

DESCRIPTION

The fully shielded PWP4 architectural wall pack adds a simple geometric accent to many commercial architectural styles. It is suitable for venues ranging from retail malls, corporate and medical campuses to industrial parks, transportation centers, and schools or universities. The luminaire is durable die-cast aluminum with horizontal tempered flat glass lens for zero uplight. The wall pack is recommended for mounting heights from 12' to 20' depending on illumination levels and uniformity requirements. Options include 10KV surge protection for regions requiring additional protection to emergency battery backup for normal or cold temperature environments.



Date: _____ Type: _____ Catalog Number: _____

Project Name: _____

ORDERING INFORMATION

LUMINAIRE						
MODEL	OUTPUT	CCT	VOLTAGE	OPTIC	FINISH	OPTIONS
PWP4 Architectural Wall Pack	23W 23 Watts	30K 3000K	UNV 120-277V	T3 Type III	DB Dark Bronze	SF Single Fuse, 120-277V models only
	47W 47 Watts	40K 4000K	347V 347-480V		CC Custom RAL Color	DF Double Fuse, 120-277V models only
		50K 5000K*				SP Surge Protection - 10KV
						PC Photocell 120-277VAC
						EM Emergency Battery Backup 120-277V models only
						EMC Cold Start Emergency Battery Backup -20°C, 90 Minutes 120-277V models only

Custom solutions are available; consult factory via phone at (864) 487-3535 ext. 258 or via email at DesignServices@EXP-Brands.com.

DLC Qualified: PWP4-47W-50K-UNV



PWP4		
PHYSICAL	HOUSING	Die-Cast Aluminum with Full Cutoff Frame
	LENS	Tempered Clear Flat Glass
	HARDWARE	Nickel-Plated Stainless Steel Hardware
	OPERATING TEMPERATURE	-40°F to 104°F
	FINISH	Powder Coat Finish
	MOUNTING HEIGHT	12 to 20 Feet

ELECTRICAL	POWER	23 Watts	47 Watts
	CURRENT	0.19 Amps @ 120 Volts 0.08 Amps @ 277 Volts	0.39 Amps @ 120 Volts 0.17 Amps @ 277 Volts
	VOLTAGE	Universal 120 to 277 Volts or High Voltage 347-480 Volts	
	DRIVER	Electronic Internal Driver, Less Than 20% THD Dimming Source Current: 150 Microamps	
	SURGE SUPPRESSION	Standard Internal Surge Protection: 6kV	
	CONTROL	0-10v Dimming for a Dimming Range of 100% to 10%	
	FREQUENCY	50/60Hz	
	POWER FACTOR	> 0.90	

PHOTOMETRIC	LED	Static White 3000K, 4000K, and 5000K
	OPTICS	Type III Distribution
	DELIVERED LUMEN OUTPUT	up to 4921 Lumens
	EFFICACY	up to 105 Lumens per Watt
	LUMEN MAINTENANCE	L70 > 50,000 Hours at 77°F*
	BUG RATING	B1-U1-G1

LIGHT DISTRIBUTIONS	CCT	DELIVERED LUMENS	
		23 Watts	47 Watts
	3000K	2228	4552
	4000K	2318	4736
	5000K	2408	4921

CERTIFICATIONS	SAFETY	ETL Listed for Wet Locations
	INGRESS PROTECTION	IP65
	WARRANTY	Five-Year Limited Warranty

DIMENSIONS

All dimensions are shown in inches.

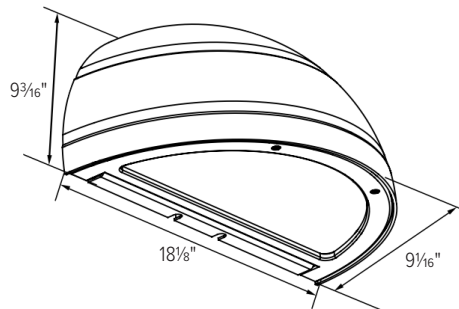

PHOTOMETRICS

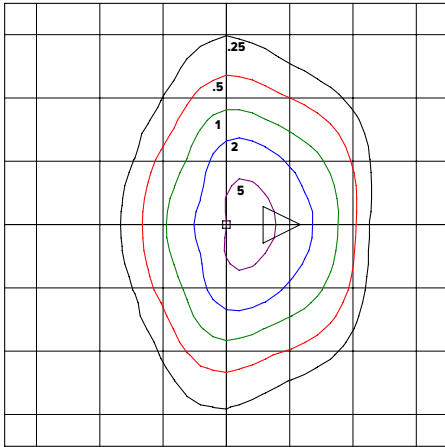

PWP4-47W-30K-UNV-T3-BRZ
3000K Mounting Height = 12.00 Ft. Each Square = 12 Ft.

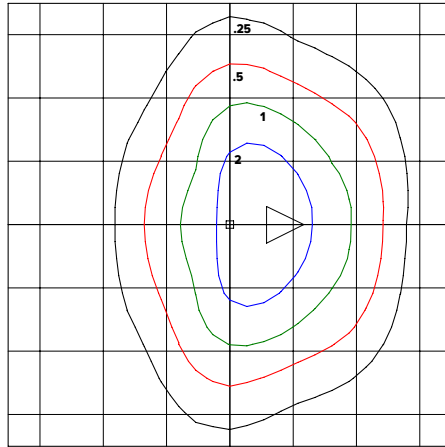

PWP4-47W-30K-UNV-T3-BRZ
3000K Mounting Height = 16.00 Ft. Each Square = 12 Ft.

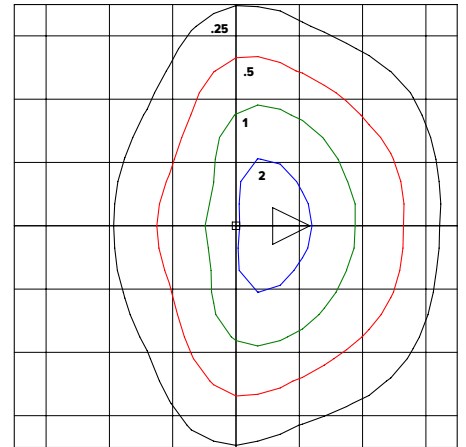

PWP4-47W-30K-UNV-T3-BRZ
3000K Mounting Height = 20.00 Ft. Each Square = 12 Ft.

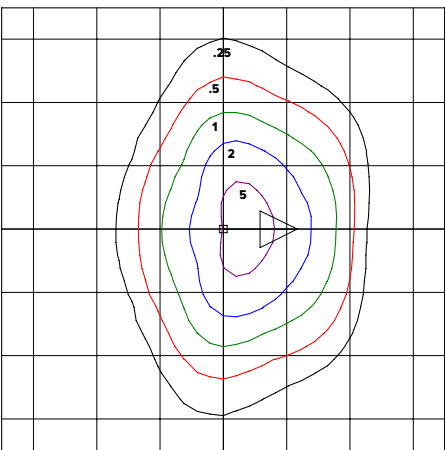

PWP4-47W-40K-UNV-T3-BRZ
4000K Mounting Height = 12.00 Ft. Each Square = 12 Ft.

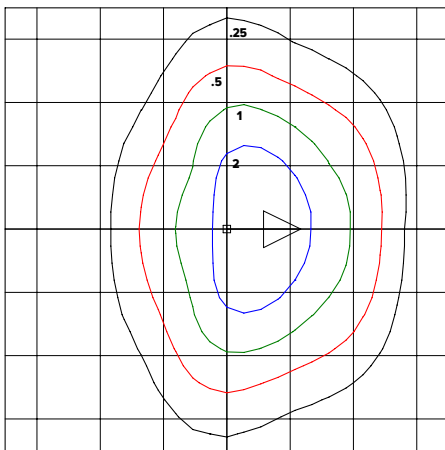

PWP4-47W-40K-UNV-T3-BRZ
4000K Mounting Height = 16.00 Ft. Each Square = 12 Ft.

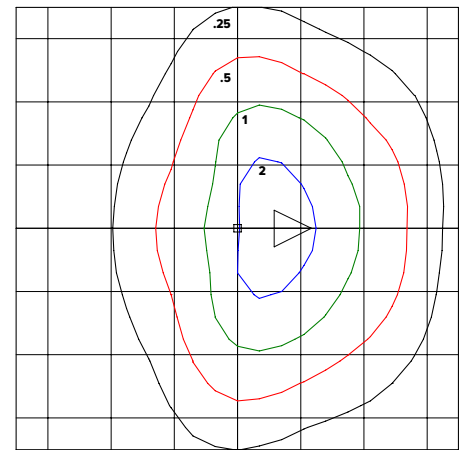

PWP4-47W-40K-UNV-T3-BRZ
4000K Mounting Height = 20.00 Ft. Each Square = 12 Ft.

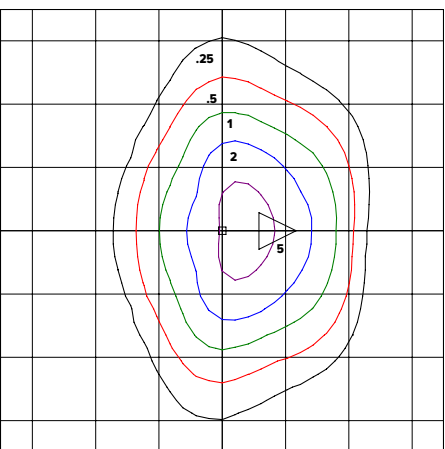

PWP4-47W-50K-UNV-T3-BRZ
5000K Mounting Height = 12.00 Ft. Each Square = 12 Ft.

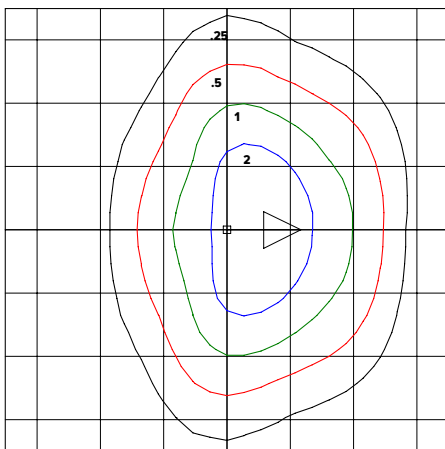

PWP4-47W-50K-UNV-T3-BRZ
5000K Mounting Height = 16.00 Ft. Each Square = 12 Ft.

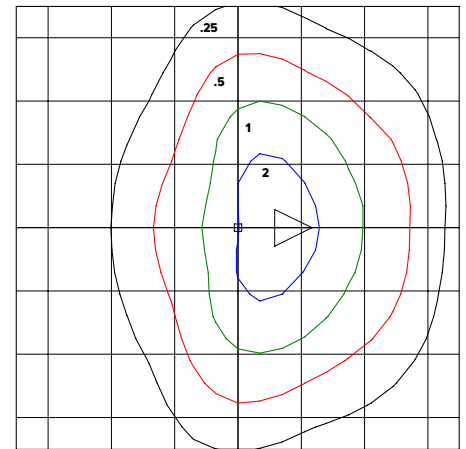

PWP4-47W-50K-UNV-T3-BRZ
5000K Mounting Height = 20.00 Ft. Each Square = 12 Ft.